

TP7 Print Area

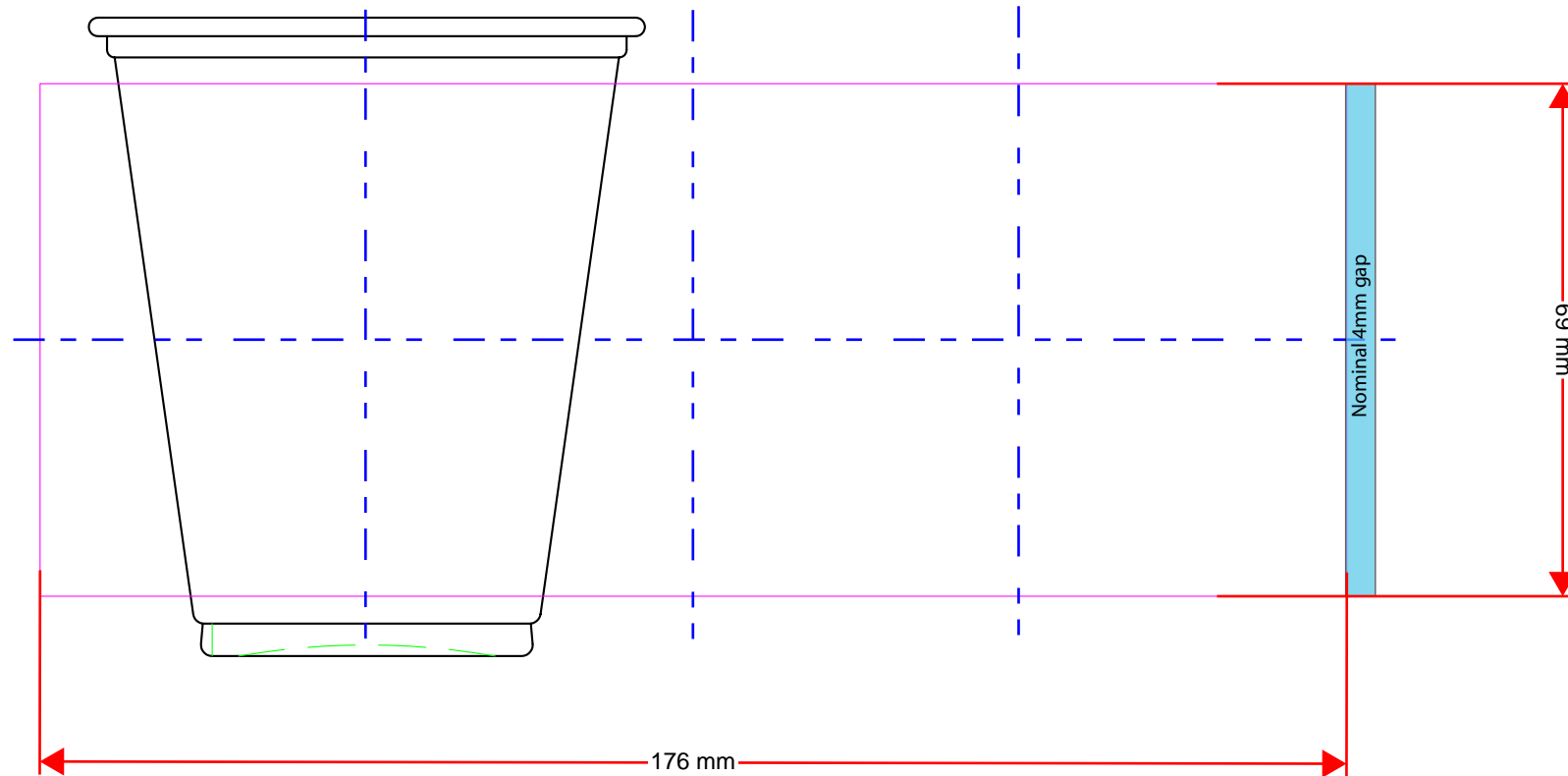

This print area does not allow for butt or overlap of print.